

Mercury Line Emission Filter

Mercury Line Emission Filter

Mercury Line Emission Filter effectively transmits emission lines of mercury lamp, therefore they are often used for the field of lithography.

This line includes filters that transmit a single emission line and multiple emission lines for mercury lamp. Each product has its high transmittance and great durability against heat because they are assembled without epoxy adhesive, and made of fused silica.

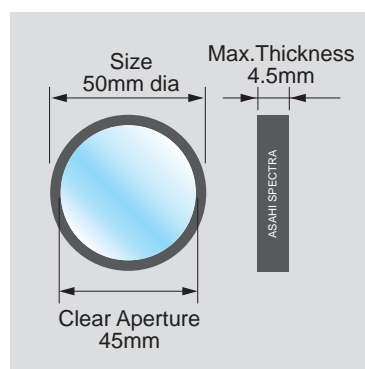
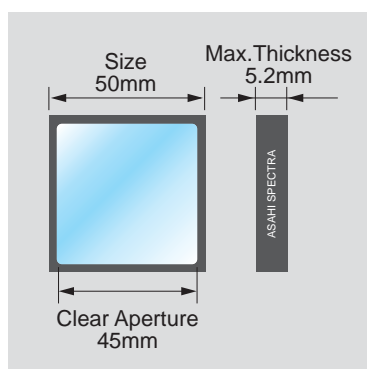
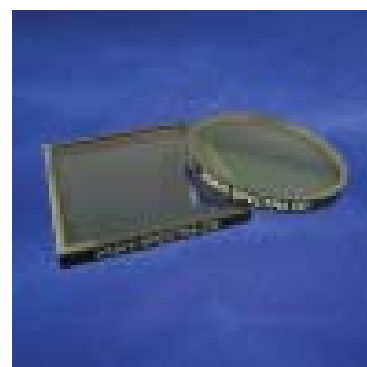

Item Number	Transmitting Emission Line (nm)	Min. transmission (%)	Dimension (mm)	Substrate	Thickness (mm)
ZHG0254	254	55	50 x 50	Fused Silica	5.2
YHG0254			50 diameter		4.5
ZHG0313	313	75	50 x 50	Fused Silica	5.2
YHG0313			50 diameter		4.5
ZHG0365	365	85	50 x 50	Fused Silica	5.2
YHG0365			50 diameter		4.5
ZHG0405	405	80	50 x 50	Fused Silica	5.2
YHG0405			50 diameter		4.5
ZHG2513	254 / 313	75	50 x 50	Fused Silica	5.2
YHG2513			50 diameter		4.5
ZHG3165	313 / 365	80	50 x 50	Fused Silica	5.2
YHG3165			50 diameter		4.5
ZHG3605	365 / 405	85	50 x 50	Fused Silica	5.2
YHG3605			50 diameter		4.5
ZHG4036	405 / 436	80	50 x 50	Fused Silica	5.2
YHG4036			50 diameter		4.5
ZHG2565	254 / 313 / 365	85	50 x 50	Fused Silica	5.2
YHG2565			50 diameter		4.5
ZHG3105	313 / 365 / 405	80	50 x 50	Fused Silica	5.2
YHG3105			50 diameter		4.5
ZHG3636	365 / 405 / 436	85	50 x 50	Fused Silica	5.2
YHG3636			50 diameter		4.5

Item Number	Transmitting Emission Line (nm)	Min. transmission (%)	Dimension (mm)	Substrate	Thickness (m m)
ZHG2505	254 / 313 / 365 / 405	70	50 x 50	Fused Silica	5.2
YHG2505			50 diameter		4.5
ZHG3136	313 / 365 / 405 / 436	80	50 x 50	Fused Silica	5.2
YHG3136			50 diameter		4.5
ZHG2536	254 / 313 / 365 / 405 / 436	70	50 x 50	Fused Silica	5.2
YHG2536			50 diameter		4.5

Shortpass

Longpass

Bandpass

Neutral Density

Mercury Line Emission

Super Cold

Others

ZHG0254

YHG0254

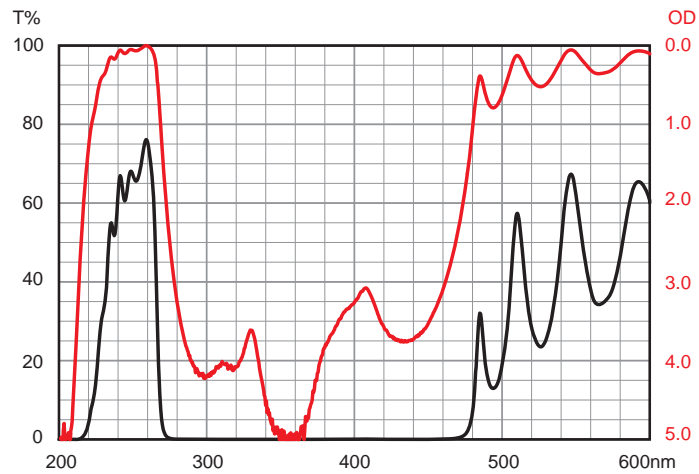

ZHG0313

YHG0313

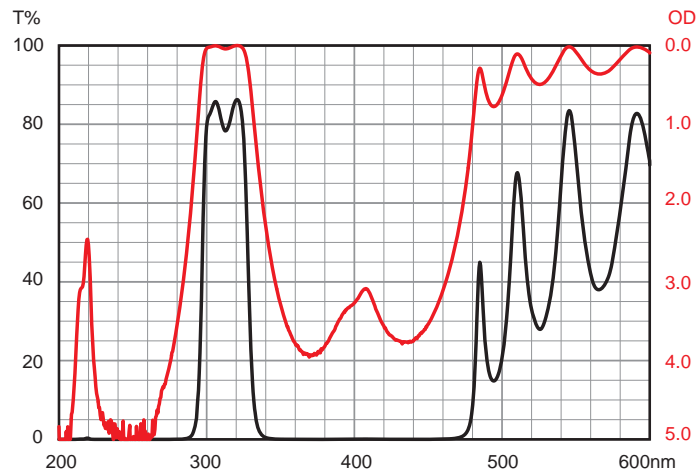

Shortpass

ZHG0365
YHG0365

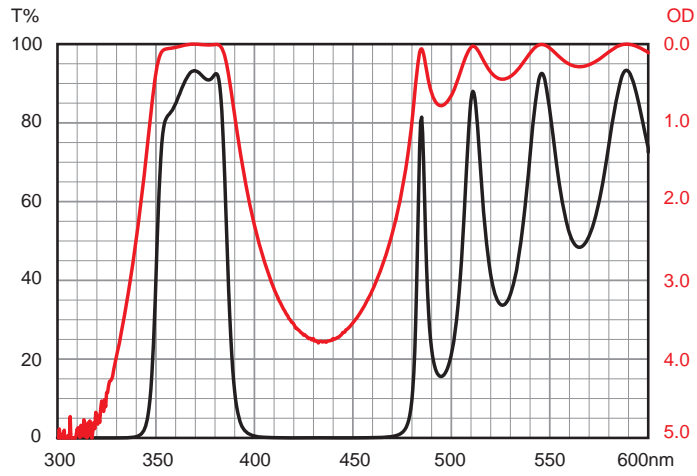

Longpass

Bandpass

Neutral Density

Mercury Line Emission

Super Cold

Others

ZHG0405
YHG0405

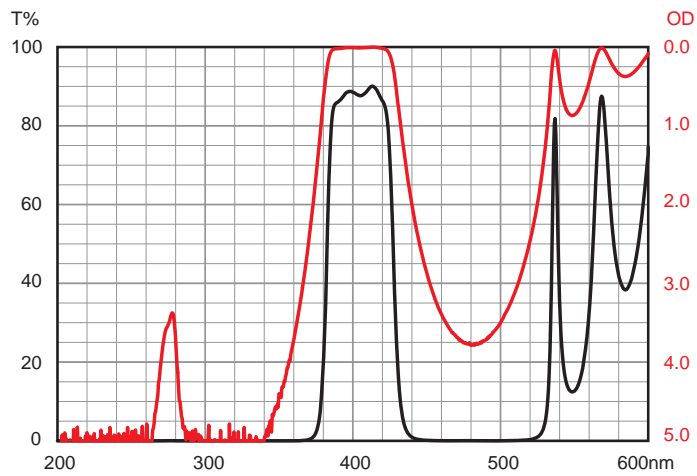

ZHG0436
YHG0436

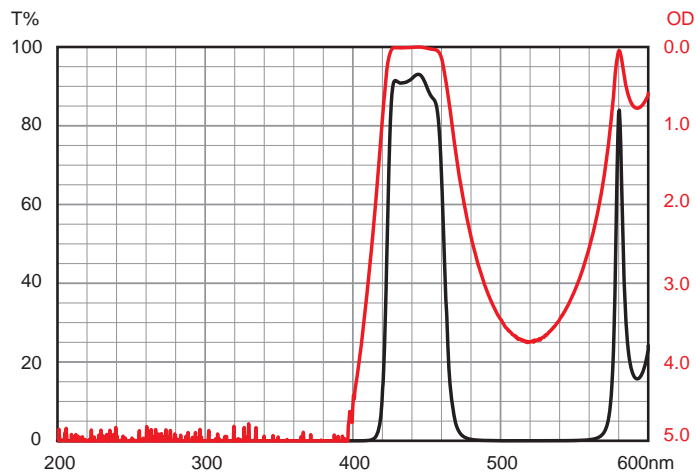

ZHG2513
YHG2513

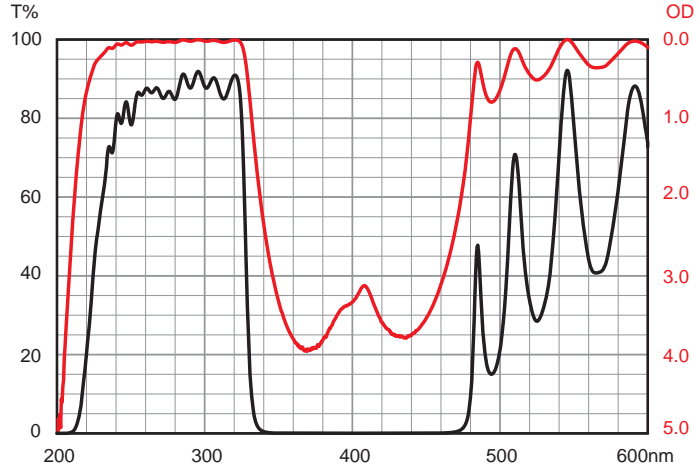

Shortpass

Longpass

ZHG3165
YHG3165

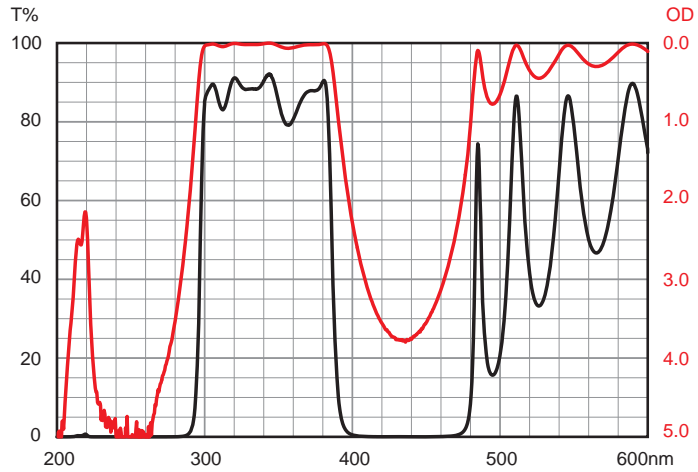

Bandpass

Neutral Density

ZHG3605
YHG3605

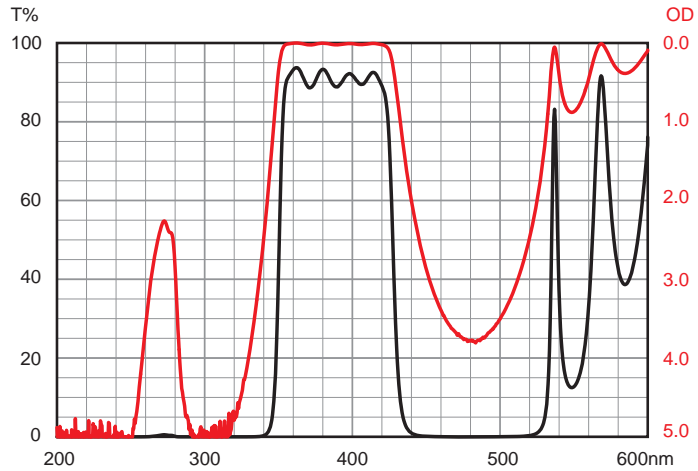

Mercury Line Emission

Super Cold

Others

Shortpass

ZHG4036
YHG4036

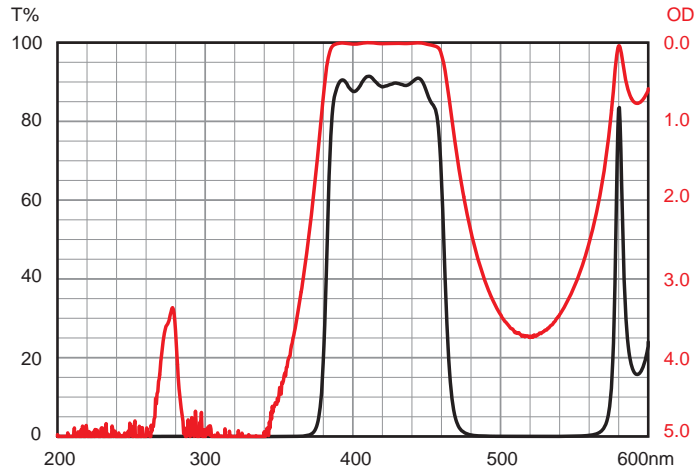

Longpass

Bandpass

Neutral Density

Mercury Line Emission

Super Cold

Others

ZHG2565
YHG2565

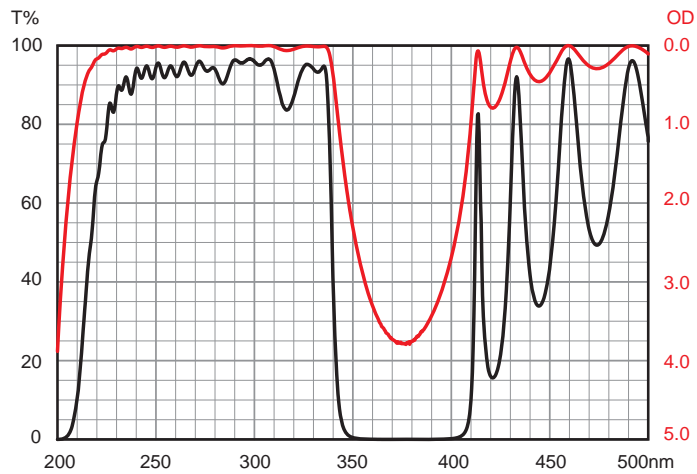

ZHG3105
YHG3105

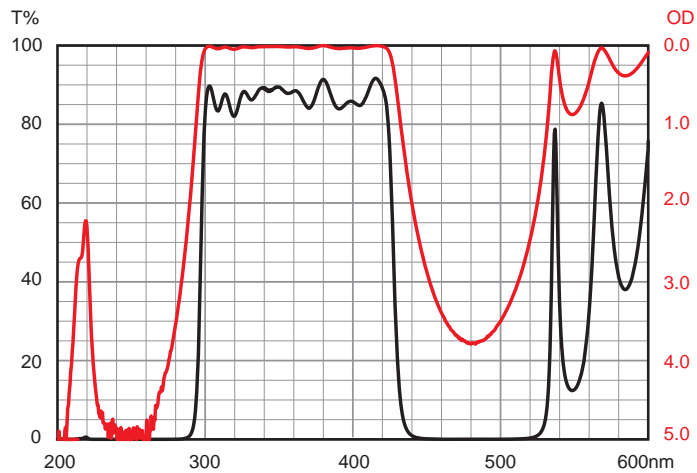

ZHG3636
YHG3636

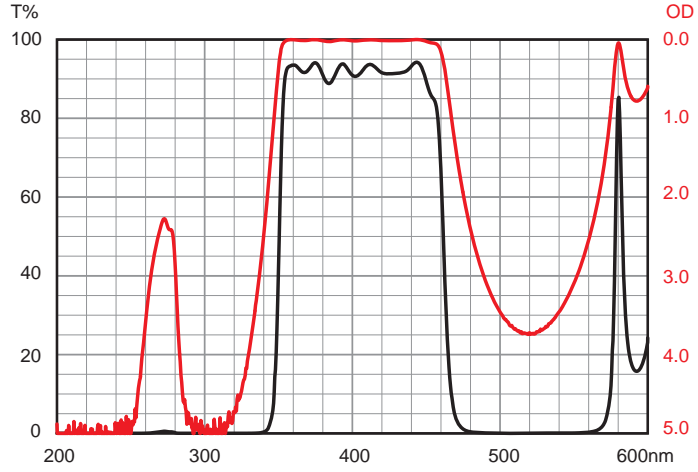

Shortpass

Longpass

ZHG2505
YHG2505

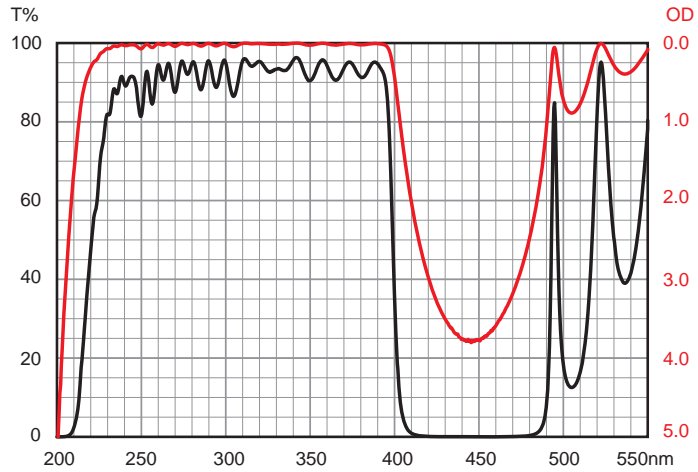

Bandpass

Neutral Density

Mercury Line Emission

ZHG3136
YHG3136

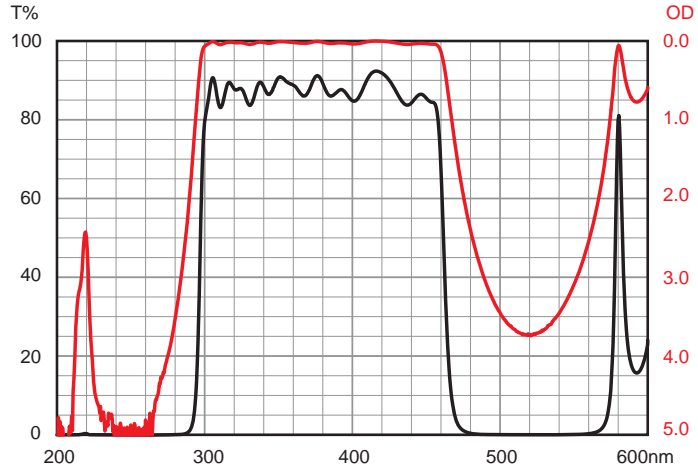

Super Cold

Others

ZHG2536
YHG2536

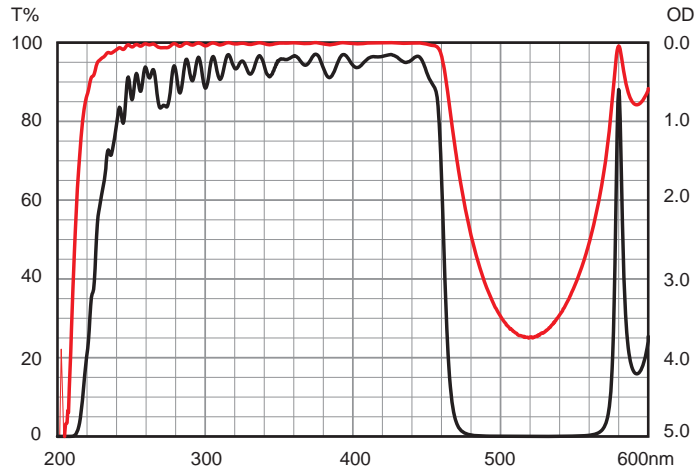

Shortpass

Longpass

Bandpass

Neutral Density

Mercury Line Emission

Super Cold

Others